

Operating Manual

TxRail-USB Temperature Transmitter

0555 0035-01 – 4-20 mA

0555 0035-02 – 0-10 V



TxRail-USB Temperature Transmitter

0555 0035-01, 0555 0035-02



Contents

.....	0
1 Foreword.....	1
2 General Advice	1
2.1 Labels.....	1
2.2 Warning Advice	1
2.3 Security Advices.....	2
3 Introduction	3
4 Technical Specifications	3
5 Mechanical Installation.....	4
5.1 Öffnen des Messumformers.....	4
6 Electrical Installation	4
6.1 Recommendations for Installation	5
6.2 Electrical Connections.....	5
6.2.1 Pt100 2-wires / NTC	5
6.2.2 Pt100 3-wires.....	5
6.2.3 Pt100 4-wires.....	5
6.2.4 Thermocouples and 0 – 50 mV	5
6.2.5 Output.....	6
7 Configuration.....	6
7.1 Software Configuration.....	7
7.2 Factory Settings	7
8 Operation	7
9 Questions?.....	8

TxRail-USB Temperature Transmitter

0555 0035-01, 0555 0035-02



1 FOREWORD

Dear customer,

We thank you for having purchased the **TxRail-USB** Temperature Transmitter and are very glad that you decided in favour of a product of B+B Thermo-Technik GmbH. We hope this product will fully satisfy you and will assist you effectively in your work.

This Device has been developed to be technically highly up-to date. This product has been designed in accordance with the regnant European and German national directives and rules. For a proper and effective usage of the product the customer shall observe the following Operating Instructions. In the case that against one's expectations any troubles occur which you cannot resolve yourself, please contact our service centers or your salesperson. We go after giving you rapid and competent help to minimize the risk of long-time outfalls.



The following operating Instruction is an indispensable part of this Product. It contains important advices for the starting up and further use of the device

2 GENERAL ADVICE

This documentation contains information which must be paid in attention to assure a highly effective and secure use of the supplied product Please read through the following instructions and make yourself familiar with the handling of the product before you insert it in your processes. Keep this document always readily to hand so you can consult it by need.

2.1 Labels

Symbol	Meaning	Descripton
	Advice	It is necessary to read the following advice before beginning the operations. The used symbols in the manual acts first as eye catcher for security risks. The symbols do not replace the security advice. The text must be read to the end
	Necessary to observe	This symbol designates important advice and tips that are necessary for the success a work step. They must be followed to get good results

2.2 Warning Advice

Symbol	Meaning	Symbol	Meaning
	This symbol advises the user of danger for persons, material, or environment. The text gives information that must be necessarily followed to avoid any risks		Caution against electromagnetic fields (BGV A8, GUV-V A8/W12)
	Caution against hot surfaces (BGV A8, GUV-V A8/W26) and hot liquids or substances		Caution against severe cold (BGV A8, GUV-V A8/W17)
	Caution against liquids and hot substances		Caution against dangerous high electrical voltage (BGV A8, GUV-V A8/W08)
	Caution against dangerous ex-plosive substances (BGV A8, GUV-V A8/W02)		Caution against dangerous explosive atmosphere (BGV A8, GUV-V A8/W21)
	Caution against mobile engines (W29) Caution against moving parts		Electronic waste

TxRail-USB Temperature Transmitter

0555 0035-01, 0555 0035-02



2.3 Security Advices

B+B Thermo-Technik GmbH assume no liability for damages occurred through failure to observe these security advices. A usage non conform to the instructions given in this manual can damage the device

BODY AND PROPERTY DAMAGES



The national and local standards for electrical installations must be strictly observed.
The use of the device is strictly reserved / restricted to properly schooled / qualified operators.



The system is not adequate for use in atmosphere with explosion danger.



Do not use the system in a high electric or magnetic field area

ENSURING OF PRODUCT SECURITY



The system must be operated only within the limits given in the technical Data
Exposing the system to hot temperatures (higher than the operating temperature) will cause damages in the electronic circuits and also damage the housing

USAGE ACCORDING TO PURPOSE



Please use the product only for the purposes for which it is conceived. In case of doubt, please first contact B+B Thermo-Technik GmbH

DISOPOSAL



Please return the device to B+B Thermo-Technik GmbH after expiration of its lifetime

TxRail-USB Temperature Transmitter

0555 0035-01, 0555 0035-02



3 INTRODUCTION

The TxRail-USB is an USB configurable DIN rail mount temperature transmitter. It allows selection and configuration of input type, measurement range, output type and calibration. Its output can be set to either loop powered 4-20 mA or 0-10 Vdc. Highly accurate and user-friendly, the TxRail-USB performs well from simple to sophisticated measurement applications.

The output current or voltage is linearized according to the selected input sensor and adjusted to the configured range.

4 TECHNICAL SPECIFICATIONS

Sensor Input



**Thermocouples
Pt100**

Pt1000

**NTC R₂₅°C
Voltage**

User defined. The supported sensors are listed in Table 1, along with their maximum ranges.

Maximal Voltage on the Sensor terminals 3 V

Type J, K, R, S, T, N, E and B, according to DIN EN 60584 (ITS-90). Impedance >> 1 MΩ
Excitation 0.8 mA, α= 0.00385, according to DIN EN 60751 (ITS-90).

For 2-wire sensors, terminals 3 and 4 must be short circuited.

Excitation 0.8 mA, α= 0.00385, according to DIN EN 60751 (ITS-90).

For 2-wire sensors, terminals 3 and 4 must be short circuited.

10 kΩ ±1 %, B_{25/85} = 3435

0 ... 50 mVDC. Impedance >> 1 MΩ

Sensor type	Maximal Range	Minimal Linearisation span
Spannung	0 ... 50 mV	5 mV
Thermoelement K	-150 ... 1370 °C	100 °C
Thermoelement J	-100 ... 760 °C	100 °C
Thermoelement R	-50 ... 1760 °C	400 °C
Thermoelement S	-50 ... 1760 °C	400 °C
Thermoelement T	-160 ... 400 °C	100 °C
Thermoelement N	-270 ... 1300 °C	100 °C
Thermoelement E	-90 ... 720 °C	100 °C
Thermoelement B	500 ... 1820 °C	400 °C
Pt100	-200 ... 650 °C	40 °C
Pt1000	-200 ... 650 °C	40 °C
NTC	-30 ... 120 °C	40 °C

TABELLE 1 SUPPORTED SENSORS

**Terms of reference
Temperature effects
Switch-on delay
Excitation
Wiring**

**Pt100, Pt1000, NTC
Pt100, Pt1000, NTC**

Ambient 25 °C; Voltage: 24 VDC, Load: 250 Ω; Setting time: 10 min
< ±0,16 % / 25 °C

typical 2,5 s . the accuracy is guaranteed only after 15 minutes

800 μA

Maximal allowable cable resistance 25 Ω

Cable resistance effect 0,005 °C / Ω

Accuracy

Sensor	Typical	Max.
Pt100 / Pt1000 (-150 .. 400 °C)	0,10 %	0,12%
Pt100 / Pt1000 (-200 .. 650 °C)	0,13 %	0,19%
mV, K, J, T, E, N, R, S, B	0,1 % (*)	0,15 % (*)
NTC	0,3 °C	0,7 °C

TABELLE 2 Sensor accuracy

(*) Add cold junction compensation: < ± 1 °C

**Power supply influence
Output**

4-20 mA

0,006 % / V typical (% of FS).

4-20 mA or 20-4 mA, 2-wire, linear, proportional to the configured range

TxRail-USB Temperature Transmitter

0555 0035-01, 0555 0035-02



Resolution	0-10 V 4-20 mA	0-10 VDC or 10-0 VDC linear, proportional to the configured range 2 μ A
Power supply	0-10 V 4-20 mA Output 0-10 V Output	0,0025 V (12 bits) 10 ... 35 VDC 12 ... 35 VDC
Maximal Load		$RL \text{ (max.)} = (VDC - 10) / 0,02 \text{ [}\Omega\text{]}$ where VDC= Power supply (10-35V)
Operating Temp.		-40...85 °C
Humidity		0...90 % RH
EM Compatibility		EN 61326-1:2006
Wires		No electrical isolation between input and output. Internal protection against polarity inversion Cold junction compensation for thermocouples 0,14 ... 1,5 mm ²
Screw Tightening		0,8 Nm (empfohlen)
Housing		ABS UL94-HB
Certificates		CE

5 MECHANICAL INSTALLATION

The TxRail-USB transmitter is suitable to be installed on 35 mm DIN rail. Vibrations, moisture and extreme temperatures, electro-magnetic interference, high voltage and other interferences can permanently damage the unit, and could cause error in the measured value. Abmessungen



ABBILDUNG 2 Opening the Transmitter

5.1 Öffnen des Messumformers

To open the transmitter, you must press the orange lockers located on both sides of the enclosure and pull the frontal cover very carefully, just like shown in Fig. 2.

6 ELEKTRICAL INSTALLATION

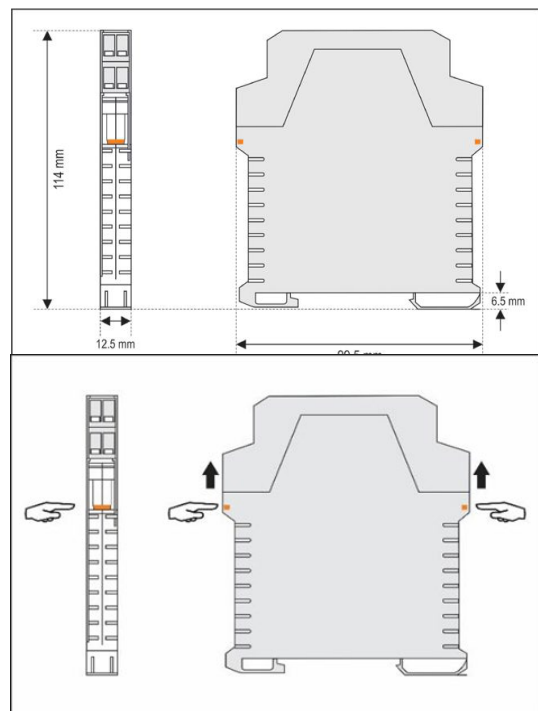
- Housing made of polyamide
- Cable / wires: 0,14 ... 1,5 mm²

TxRail-USB Temperature Transmitter

0555 0035-01, 0555 0035-02



- Recommended torque for the connection screws: 0.8 Nm

6.1 Recommendations for Installation

- Conductors of small electrical signals must be distant from Power supply and high-tension/current conductors, preferably passing through grounded conduits.
- A specific electrical power supply network should be provided for instruments use only
- In controlling and monitoring applications, possible consequences of any system failure must be considered in advance.
- RC filters (47R an 100nF, serial) in inductor charges (contactors, solenoids, etc.) are recommended

6.2 Electrical Connections

The figures below show the electrical connections required. The terminals 1, 2, 3 and 4 are dedicated to the sensor connection. LOAD represents the 4-20 mA current or 0-10 V voltage measuring device (indicator, controller, recorder, etc.).

6.2.1 Pt100 2-wires / NTC

Note: When the Pt100/Pt1000 2-wire the terminals 1 and 3 must be interconnected, according to the figure below. To use the Pt100/Pt1000 2-wire, you must configure the Pt100/Pt1000 3-wire option in TxConfig II. The Pt100/Pt1000 wire length should be less than 30 cm to maintain the measurement error within specifications (electrical resistance).



ABBILDUNG 3

6.2.2 Pt100 3-wires

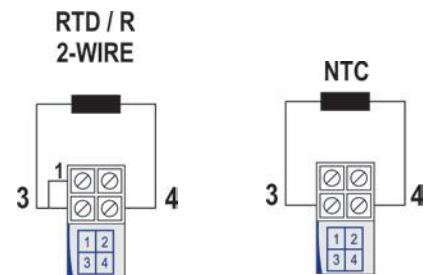

ABBILDUNG 4

6.2.3 Pt100 4-wires

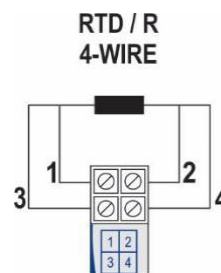

ABBILDUNG 5

Pt100 3 and 4-wire: For appropriate cable resistance compensation they should be equal for all legs. Maximum wire resistance is 25 Ω per wire leg. Usage of a 3 or 4 wire with conductors of equal length and gauge is recommended.

6.2.4 Thermocouples and 0 – 50 mV

THERMOCOUPLE SENSOR

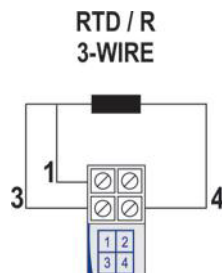

ABBILDUNG 6

0-50 mV / 0-100 mV

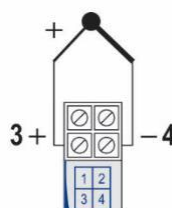
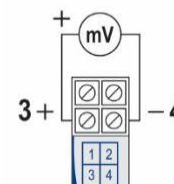

TxRail-USB Temperature Transmitter

0555 0035-01, 0555 0035-02

ABBILDUNG 7

6.2.5 Output



ABBILDUNG 8 Strom (rechts) - Spannung (links)

7 CONFIGURATION

Changes to the configuration are possible through the TxConfig II software, provided free of charge. The transmitter configuration interface (USB cable) can be purchased from the manufacturer or its authorized sales representatives.

The TxConfig II software is continuously updated, and new versions can be downloaded at no charge from the manufacturer's website. To install, execute the TxConfigIISetup.exe file and follow the instructions.

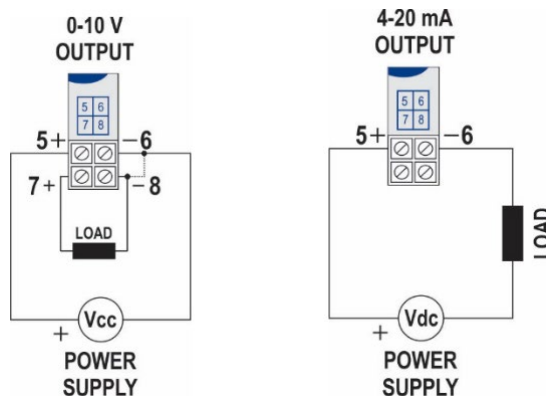
During the setup, the transmitter is powered by the USB, not requiring an external power supply. The transmitter setup can also be made by connecting it to the loop, using the *loop* power supply. There is no electrical insulation between the transmitter and the communication port (interface), therefore it is not recommended to configure it with the sensor inlet connected to the process. See **Fig. 2**



ABBILDUNG 9 USB cable connection

After these connections, the user must run the TxConfig II software and, if necessary, consult the Help topic to help using the software.

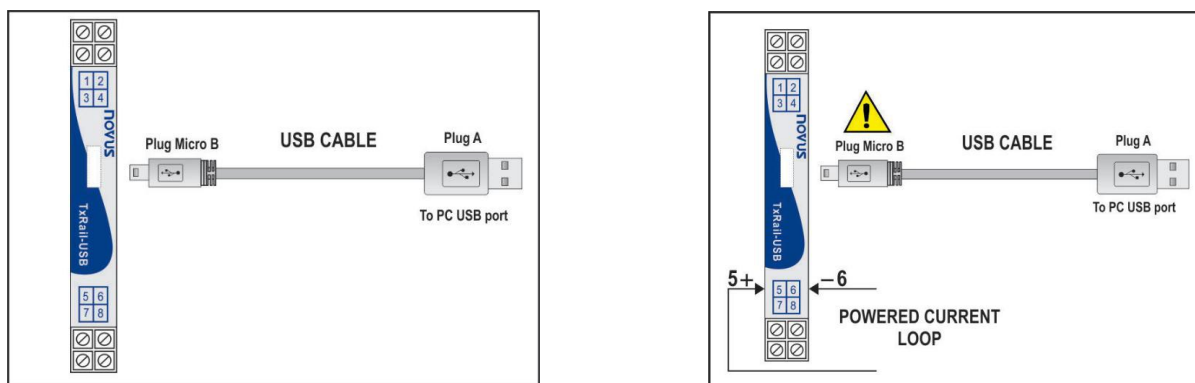

The USB communication port (interface) of the TxBlock-USB is not electrically insulated from the transmitter's input.

TxRail-USB Temperature Transmitter

0555 0035-01, 0555 0035-02

7.1 Software Configuration



ABBILDUNG 10 Hauptfenster TxConfig II

The fields in the screen mean:

1. **General Information:** This field shows information that identifying the transmitter. This information should be sent to the manufacturer in an eventual request for technical assistance.
2. **Sensor:** Select the type of sensor to be used. See Table 1.
3. **Measuring Range:** Sets de measurement range of the transmitter.
 - a. **Lower Range Limit:** Desired temperature for minimum retransmission value.
 - b. **Upper Range Limit:** Desired temperature for maximum retransmission value.
 - c. **Sensor Range** The values chosen cannot exceed the range of sensor shown in this field. See Table 1 of this manual.
 - d. **Minimum Range** Do not set a lower band (span) that the Minimum Range indicated below in this same field. See Table 1 of this manual.
4. **Sensor Failure:** It establishes the output behavior, when the transmitter indicates a failure:
 - a. **Minimum:** output current goes to < 3.8 mA or output voltage is 0 V (down-scale), typically used for refrigeration.
 - b. **Maximum:** output current goes to > 20.5 mA or output voltage is 10 V (up-scale), typically used for heating.
5. **Zero Correction:** It corrects small deviations presented in the transmitter output, for example, when the sensor is replaced.
6. **Send Configuration:** It applies the new setup. Once sent, the setup will be immediately adopted by the transmitter.
7. **Read Configuration:** Reads the current setup in the transmitter connected. The screen now presents the current setup that may be changed by the user.

7.2 Factory Settings

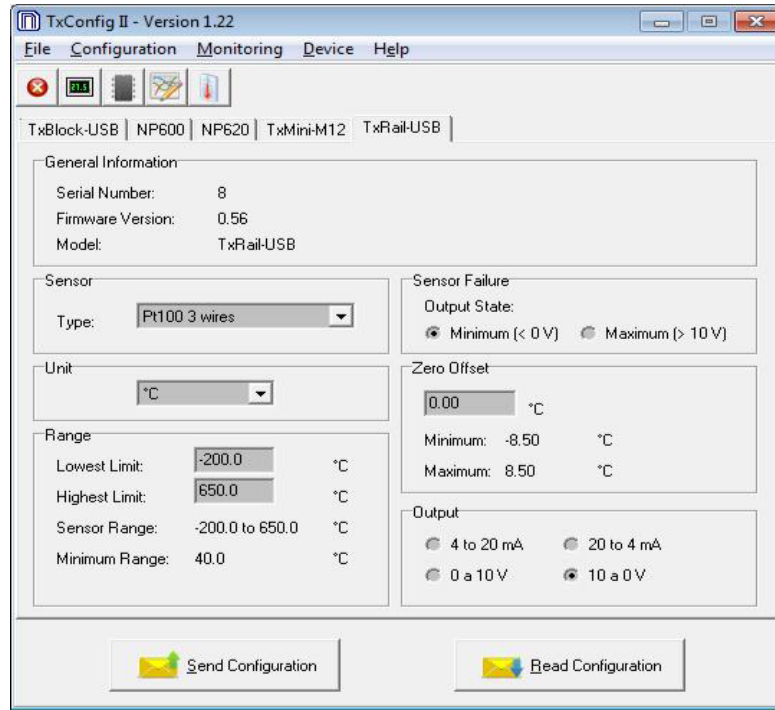
- Sensor: Pt100 3-wire, range 0 to 100 °C
- Sensor failure: upscale (maximum).
- 0 °C zero correction.
- Unit: °C;
- Output: 4-20 mA.

8 OPERATION

The sensor offset can be changed through the TxConfig II software. The USB cable may be connected to the transmitter without causing

TxRail-USB Temperature Transmitter

0555 0035-01, 0555 0035-02



any measurement errors. See item Zero Correction in the chapter CONFIGURATION of this manual.

The user must choose the most suitable sensor and range to the process. The chosen range must not exceed the maximum range of measurement defined for the sensor and should not be smaller than the minimum range for the same sensor.

It is important to note that the transmitter accuracy is based on the maximum range of the sensor used, even when a narrower range is programmed. Example:

- The Pt100 sensor in the range 0 to 100 °C and accuracy of 0.12 %, the maximum error will be 1.02 °C (0.12 % de 850 °C).
- The Pt100 sensor in the range 500 to 600 °C and accuracy of 0.19 %, the maximum error will be 1.61 °C (0.19 % of the 850 °C).

Note: When measurements are made at the transmitter, see if the Pt100 excitation current required by the calibrator is compatible with the Pt100 excitation current used in the transmitter: 0.8 mA

9 QUESTIONS?

For further Information about this or other products of B+B Thermo-Technik GmbH please do not hesitate to contact us at:

B+B Thermo-Technik GmbH
Heinrich-Hertz-Straße 4
78166 Donaueschingen
Deutschland

Tel.: +49 771 83160
Fax: +49 771 831650

E-Mail: info@bb-sensors.com
www.bb-sensors.com